

# Sluse P.-250

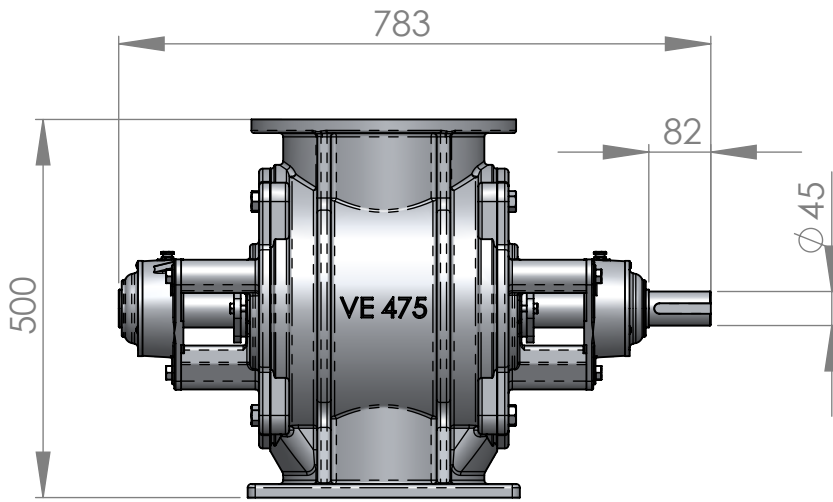

Vægt ca. 175 kg

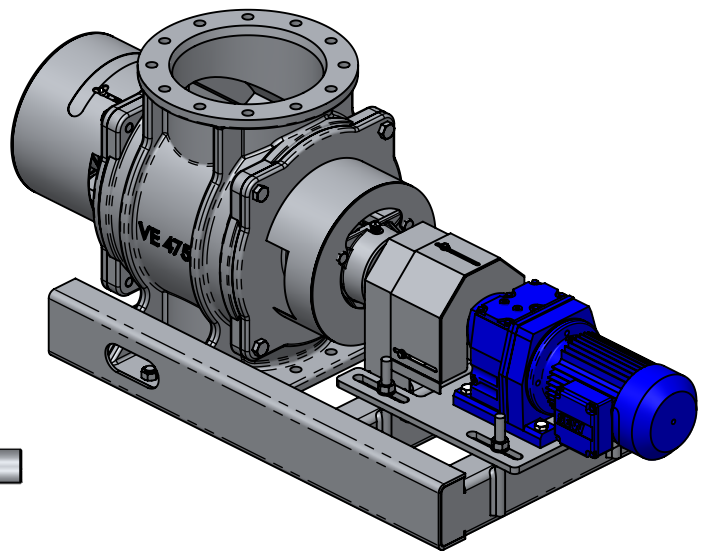
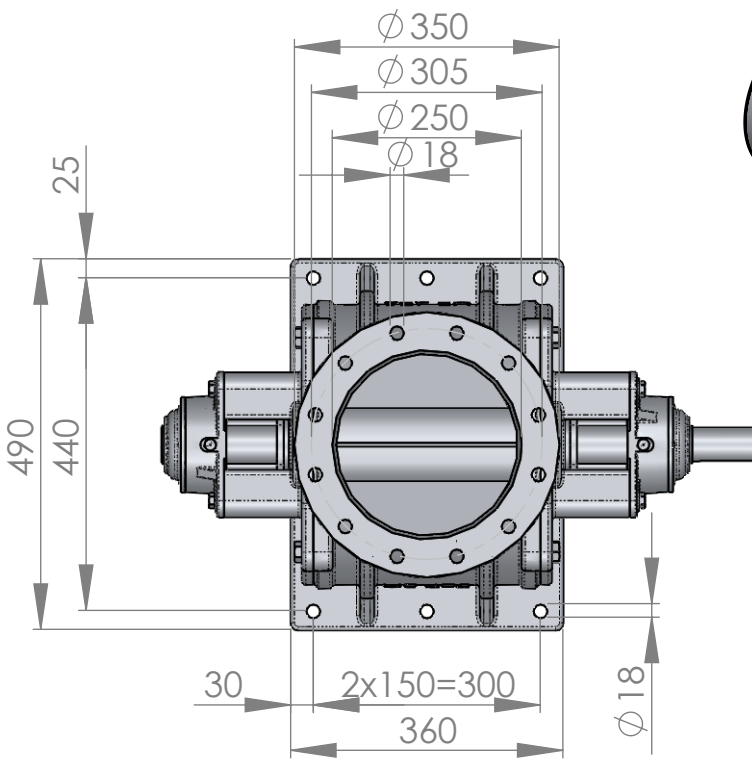

P- ø250

