

PAM sluse 1200/1200 UL

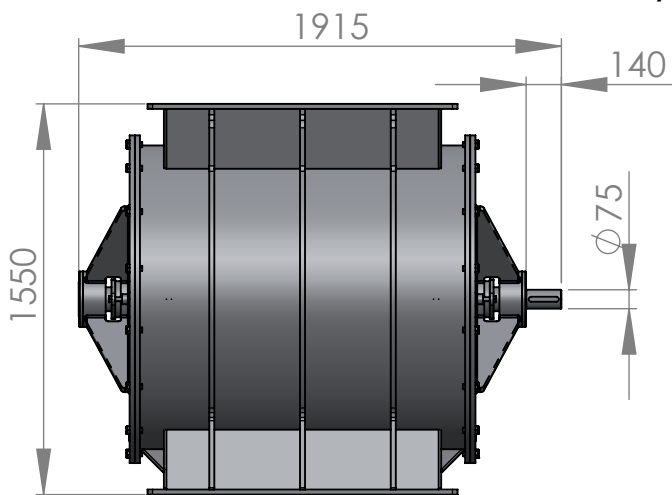

Vægt ca. 2700 kg

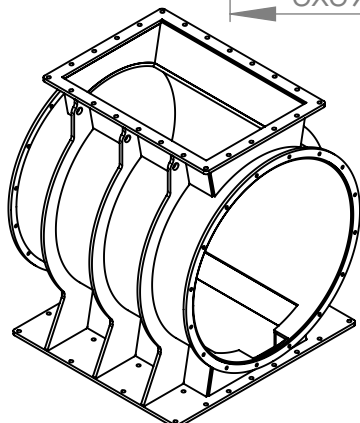
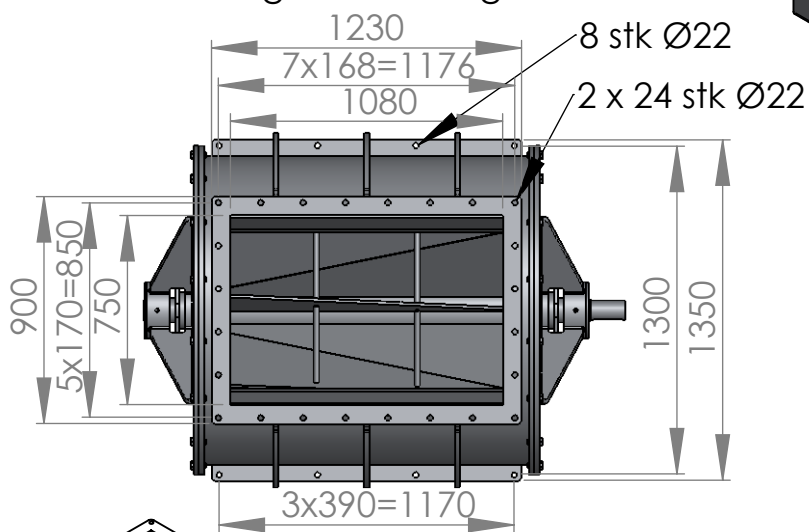
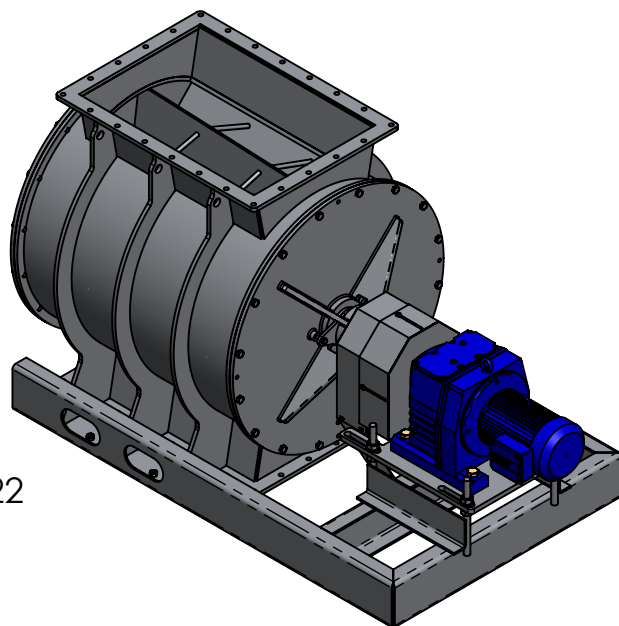

Standard

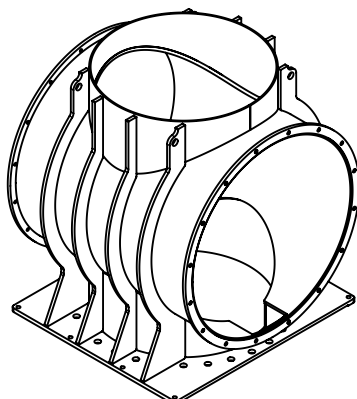

Alternativ

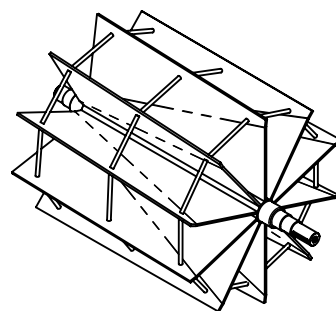

Åben rotor med faste vinger

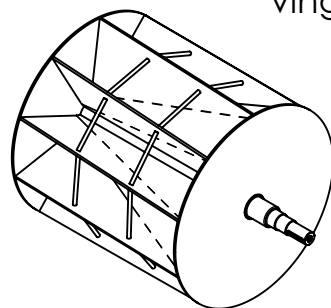

Lukket rotor med faste vinger

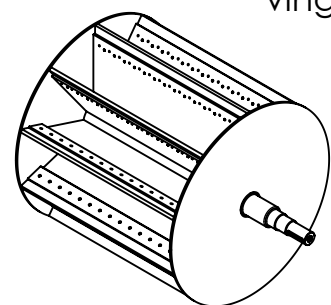

Lukket rotor med udskiftelige gummi eller vulkollan vingespidser

1200/1200 UL

